

TCP Smart rt

WIFI OIL FILLED RADIATOR

TCP Smart WiFi Oil Radiator is a low cost solution for quickly heating a room. Ideal for home, office or workshop. Lightweight, silent and portable. Complete with castors so the radiator can be moved from room to room. The Smart features allow for full voice via Alexa and Google. Direct control via the TCP Smart App. Save money through efficiently heating the room and not the home.

USER INSTRUCTIONS

MODEL	POWER	
SMAWHOILRAD1500WEX15	AC220-240V	50-60Hz 1500W Class II
SMAWHOILRAD2000WEX20	AC220-240V	50-60Hz 2000W Class II
SMABLOILRAD2000WEX20	AC220-240V	50-60Hz 2000W Class II
SMAWHOILRAD2500WEX25	AC220-240V	50-60Hz 2500W Class II

IMPORTANT: These instructions are for your safety. Please read thoroughly before use and retain for future reference.

SAFETY INSTRUCTIONS (to be read before operating the heater).

1. Before using turn the heater on using the ON/OFF button  which is located at the front of the heater.
2. **CAUTION:** Some parts of this product can become very hot and cause burns. Particular attention has to be given where children and vulnerable people are present. Children 3 years and younger should be continually supervised when in close proximity to the heater. Children aged 3 to 8 years shall only switch on/off the appliance provided that it has been placed or installed in its intended normal operating position and they have been given supervision or instruction concerning use of the appliance in a safe way and understand the hazards involved. Children aged 3 to 8 years shall not plug in, regulate and clean the appliance or perform user maintenance.
3. Use this heater on a flat or horizontal and stable surface.
4. Keep the power cord away from the hot body of the heater.
5. Indoor use only.
6. Do not use the heater in areas where flammable liquids are stored or where flammable fumes may be present.
7. Do not use this heater if it has been dropped; or there is visible signs of damage
8. Do not place the heater close to curtains or furniture in order to avoid a fire hazard.
9. Do not leave the heater switched on when your property is vacant.
10. Ensure the power supply to the socket into which the heater is plugged is in accordance with the rating label on the heater and that the socket is earthed.
11. Always ensure the heater is operated in a well-ventilated area.

WARNINGS

- In order to avoid overheating, do not cover the heater.
- Always use the heater in an upright position.
- If the supply cord is damaged, it must be replaced by the manufacturer, their service agent or a similarly qualified person in order to avoid a hazard.
- Do not use this heater in the immediate surroundings of a bath, a shower or a swimming pool.
- In order to avoid a hazard due to inadvertent resetting of the thermal cut out, this appliance must not be supplied through an external switching device, such as a timer, or connected to a circuit that is regularly switched on and off by the utility.
- Do not use the heater to dry your laundry. Never obstruct the intake and outlet grilles to avoid the danger of overheating.
- Always use this appliance with feet fixed in place.

INSTALLATION

Your appliance should be used as a portable appliance only.

Install the feet as shown below. Always use your heater with the feet fitted.

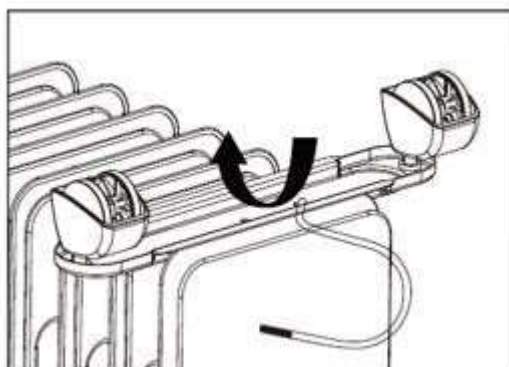



MANUAL CONTROL OF RADIATOR

Manual Settings using the LCD screen

Choose a suitable location for the RADIATOR, taking into account the safety instructions above.

ON/OFF BUTTON

Press the on button until you hear a bleep sound. The display will show . Press  button to turn the heater on.

This feature can be performed using the TCP Smart App.

TEMPERATURE BUTTON



Rotate the mode button  clockwise or anticlockwise to increase or decrease the target temperature. The temperature range is from 5°C to 35°C.

ANTI FROST



This function is used to ensure the product does not freeze during periods of extreme cold.

Once the Anti-frost mode is selected the target temperature will be overridden and the heater will stay at 7°C until the anti-frost function is turned off.

For this function to work the heater must be turned on with the target temperature set at the lowest



temperature (5°C). Turn the  anticlockwise. The screen will display **Fr**. The target temperature will then be fixed at 7°C. Exit by turning the  clockwise.

HEATING SELECTION

Press this button once. The screen will display H1, H2 or H3. Rotate the  button to cycle between H1, H2 or H3 options. After choosing the desired heating level, wait 5 seconds or press  to return to target temperature display. The heating selection is now set.

Note: H1 is Low Heating, H2 is Medium Heating and H3 is High Heating.

TIMER BUTTON

Press and hold  button for 3 seconds until the screen displays **00H**. The H will keep flashing. Turn the  button to choose the desired time from 1-24 hours. Wait 5 seconds or press the  button to finish the setting. When the timer has been set the remaining time and target temperature will be displayed in a continuous cycle 5 secs apart. From the moment the time is set the timer will continue to count down. Once completed the radiator will switch off.

CLEANING THE HEATER

Allow heater to cool down before cleaning. Clean the outside of the heater by wiping with a damp cloth and buff with a dry cloth. Do not use any detergents or abrasives.

CORRECT DISPOSAL OF THIS PRODUCT



WARRANTY INFORMATION

The manufacturer provides warranty in accordance with the legislation of the customer's own country of residence, with a minimum of 2 years, starting from the date on which the appliance is sold to the end user.

The warranty only covers defects in material or workmanship.

The repairs under warranty may only be carried out by an authorized service centre. When making a claim under the warranty, the original bill of purchase (with purchase date) must be submitted. The warranty will not apply in cases of:

Normal wear and tear

- Incorrect use, e.g. overloading of the appliance, use of non-approved accessories
- Use of force, damage caused by external influences
- Damage caused by non-observance of the user manual, e.g. connection to an unsuitable mains supply or non-compliance with the installation instructions
- Partially or completely dismantled appliances.

CERTIFICATION CONFORMITY

- Hereby, Technical Consumer Products Ltd declares that the radio equipment type TCP Smart Wifi Oil Filled Radiator 1500W – White, TCP Smart Wifi Oil Filled Radiator 2000W – White, TCP Smart Wifi Oil Filled Radiator 2000W – Black, TCP Smart Wifi Oil Filled Radiator 2500W – White is in accordance with Directive 2014/53/EU.
- The full text of the EU declaration of conformity is available at the following internet address – <https://tcpi.eu/compliance-data/>

REGISTERED OFFICES

- TCP UK Ltd, 1 Exchange Court, Cottingham Road, Corby, Northants, NN17 1EW.
- TCP France, Quai Gabriel P'ri, 1, Joinville Le Point, France, 94340.

CONNECTING THE APPLIANCE TO WI-FI

Use the QR code below to download the TCP Smart App for control of the heater by voice or TCP Smart App.



QR code for both android and iOS



To control the heater using the TCP Smart App the unit must be turned on.

Before you get started you will need the following:

- Smart device such as a mobile phone or tablet
- Access to the Google or Apple App store, log on and passwords
- The name of your Wi-Fi network and password to your Wi-Fi network
- Confirm your home Wi-Fi router is running on 2.4Ghz and not 5Ghz. If you are unsure, please consult your broadband provider for details on how to change the settings.
- Turn off any Wi-Fi extenders during set up
- Check you do not have any limitations on the number of devices with your broadband provider



Please note: Our products do not work on 5Ghz only 2.4Ghz.

For instructions on how to connect to Amazon Alexa or Google Nest please visit <https://www.tcpsmart.eu/how-to-alexa-google-nest>

With the heater turned on, hold down the Mode button  for 3 seconds until the WiFi symbol  at the top right hand corner of the screen blinks rapidly. When connected the  symbol will be continuously displayed. The device is now in pairing mode. In the TCP Smart App, enter your WiFi password and follow the instructions in the App to connect.

CONTROLLING THE RADIATOR VIA TCP SMART

APP BACKGROUND COLOUR

Press other functions button . To turn on slide the button  to the right. The colour at the top of the app screen will change with the target temperature. To turn off this function slide this button to the left.

Change with target temperature

ON/OFF BUTTON

Press once to turn on. Press to turn off.

LED DISPLAY SCREEN BRIGHTNESS

Press  to dim the LCD screen. Press again to return to normal brightness.

CHILD LOCK

Press to turn on. Press to turn off.

TARGET TEMPERATURE SETTING

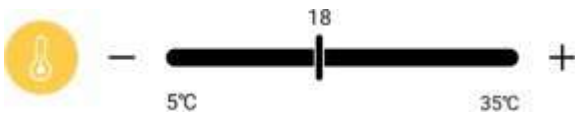

Use + and – buttons to set target temperature.

TIMER



Use the + and – buttons to set a countdown, from 1 to 23 hours. From the moment the time is set, the timer will then continue to count down. Once completed the Radiator will switch off.

MODE

M

Press . This will take you to the mode screen as below.





Select  to choose the following functions:

Heating mode  - Set using the temperature scale on the main screen. Press < to return to main screen.

Anti Frost



Select  to turn this function on. Press  to turn off. Press < to return to main screen.

Heat Level

Select one of the heat level options:



 Low Heat Setting

 Medium Heat Setting

 High Heat Setting

Press < button to return to the main screen.