



CATALOGUE

2026





WELCOME TO TCP

TCP (Technical Consumer Products) is a global, innovation-led manufacturer with a long-standing reputation in domestic and commercial lighting, and a rapidly expanding presence across Smart technology, heating and electrical solutions. Trusted by partners worldwide, TCP delivers products that combine performance, efficiency and forward-thinking design.

Alongside our extensive lighting portfolio, TCP continues to gain market share through a growing **Smart** range spanning **Heating, Lighting** and **Electrical** categories. Designed to meet the evolving needs of modern homes, commercial spaces and connected environments, these ranges offer strong commercial relevance and future-focused growth opportunities for our partners.

Our offering is further strengthened by complementary **Air Care, Cooling** and **Dehumidification** solutions, enabling retailers, wholesalers and distributors to access a broader, more profitable product mix from a single, trusted supplier.

Founded in 1993 in Aurora, Ohio, TCP was built on the belief that the quality of light equals the quality of life. That principle continues to guide our development of reliable, energy-efficient solutions for residential, commercial, industrial and infrastructure applications.

With full control over design, development, manufacturing and distribution, TCP ensures consistent **quality, compliance** and **dependable** supply. This vertically integrated approach allows us to respond quickly to market trends while delivering long-term value and confidence to our trade partners.

We welcome the opportunity to work with **retailers, electrical wholesalers** and **distributors**, offering scalable ranges, dependable supply and a collaborative approach to sustainable growth.

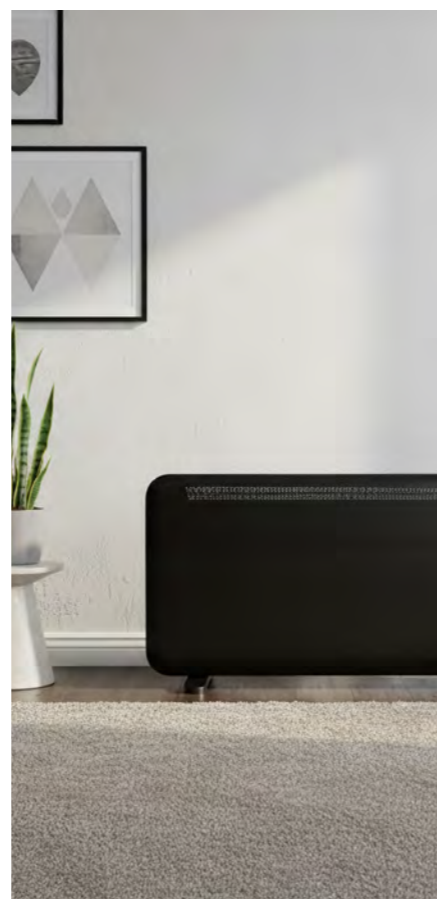



CONTENTS

07 Smart Heating
16 Heating



30 Smart Air Care
32 Air Care



36 Cooling



38 Lighting
48 Smart Lighting
52 Function Bulbs
54 Decorative



61 Smart Electrical
66 Electrical



CONTACT US







Email: customerservice@tspi.eu
Phone: +01536 201503
Website: www.tspi.eu





TCP SMART BLACK CERAMIC PANEL HEATER 700W

The TCP Smart Ceramic Panel Radiator delivers fast, efficient heating with a high-performance ceramic core and sleek, slimline design. Easy to install with plug-and-play setup, it features built-in WiFi for app control, a touchscreen display. Ideal for modern homes or offices, it offers powerful comfort with connected convenience.







-  **Instant Heat**
-  **Schedules & Timers**
-  **Digital Screen**
-  **App & Voice Control**
-  **2 Heat Modes**
-  **Black / White**

Product Specifications

TCP Smart voice control	Alexa, Google Home & Siri Shortcuts	Area coverage	8-10 M ²
TCP Smart app control	iOS & Android	Voltage	230 V
Smart schedules & timers		Colour	Black
7 Pre-installed programs		Weight	8.4 KG
Digital screen	LCD	IP rating	IPX0
Overheat protection		Cable length	1.5 M
Open window detection		WiFi	2.4 GHz
Anti frost mode		Product code (Black)	SMABLCERRAD700RB070
Wall mounted		Barcode (Black)	8720039604667
Dimensions	W 355 x D 90 x H 580 MM	Product code (White)	SMAWHCERRAD700RB070
Power	700 W	Barcode (White)	8720039602922

TCP SMART BLACK CERAMIC PANEL HEATER 1000W

The TCP Smart Ceramic Panel Radiator delivers fast, efficient heating with a high-performance ceramic core and sleek, slimline design. Easy to install with plug-and-play setup, it features built-in WiFi for app control, a touchscreen display. Ideal for modern homes or offices, it offers powerful comfort with connected convenience.

-  **Instant Heat**
-  **Schedules & Timers**
-  **Digital Screen**
-  **App & Voice Control**
-  **2 Heat Modes**
-  **Black / White**







Product Specifications

TCP Smart voice control	Alexa, Google Home & Siri Shortcuts	Area coverage	10-12 M ²
TCP Smart app control	iOS & Android	Voltage	230 V
Smart schedules & timers		Colour	Black
7 Pre-installed programs		Weight	10.4 KG
Digital screen	LCD	IP rating	IPX0
Overheat protection		Cable length	1.5 M
Open window detection		WiFi	2.4 GHz
Anti frost mode		Product code (Black)	SMABLCERRAD1000RB100
Wall mounted		Barcode (Black)	8720039604674
Dimensions	W 445 x D 90 x H 580 MM	Product code (White)	SMAWHCERRAD1000RB100
Power	1000 W	Barcode (White)	8720039602939



TCP SMART BLACK CERAMIC PANEL HEATER 1500W

The TCP Smart Ceramic Panel Radiator delivers fast, efficient heating with a high-performance ceramic core and sleek, slimline design. Easy to install with plug-and-play setup, it features built-in WiFi for app control, a touchscreen display. Ideal for modern homes or offices, it offers powerful comfort with connected convenience.

-  **Instant Heat**
-  **Schedules & Timers**
-  **Digital Screen**
-  **App & Voice Control**
-  **2 Heat Modes**
-  **Black / White**







Product Specifications

TCP Smart voice control	Alexa, Google Home & Siri Shortcuts
TCP Smart app control	iOS & Android
Smart schedules & timers	
7 Pre-installed programs	
Digital screen	LCD
Overheat protection	
Open window detection	
Anti frost mode	
Wall mounted	
Dimensions	W 535 x D 90 x H 580 MM
Power	1500 W

Area coverage	14-16 M ²
Voltage	230 V
Colour	Black
Weight	12.3 KG
IP rating	IPX0
Cable length	1.5 M
WiFi	2.4 GHz
Product code (Black)	SMABLCERRAD1500RB150
Barcode (Black)	8720039604681
Product code (White)	SMAWHCERRAD1500RB150
Barcode (White)	8720039602946

TCP SMART BLACK CERAMIC PANEL HEATER 2000W

The TCP Smart Ceramic Panel Radiator delivers fast, efficient heating with a high-performance ceramic core and sleek, slimline design. Easy to install with plug-and-play setup, it features built-in WiFi for app control, a touchscreen display. Ideal for modern homes or offices, it offers powerful comfort with connected convenience.

-  **Instant Heat**
-  **Schedules & Timers**
-  **Digital Screen**
-  **App & Voice Control**
-  **2 Heat Modes**
-  **Black / White**

Product Specifications

TCP Smart voice control	Alexa, Google Home & Siri Shortcuts
TCP Smart app control	iOS & Android
Smart schedules & timers	
7 Pre-installed programs	
Digital screen	LCD
Overheat protection	
Open window detection	
Anti frost mode	
Wall mounted	
Dimensions	W 715 x D 90 x H 580 MM
Power	2000 W

Area coverage	20-25 M ²
Voltage	230 V
Colour	Black
Weight	16.2 KG
IP rating	IPX0
Cable length	1.5 M
WiFi	2.4 GHz
Product code (Black)	SMABLCERRAD2000RB200
Barcode (Black)	8720039604698
Product code (White)	SMAWHCERRAD2000RB200
Barcode (White)	8720039602953

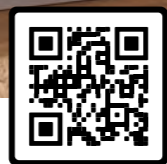
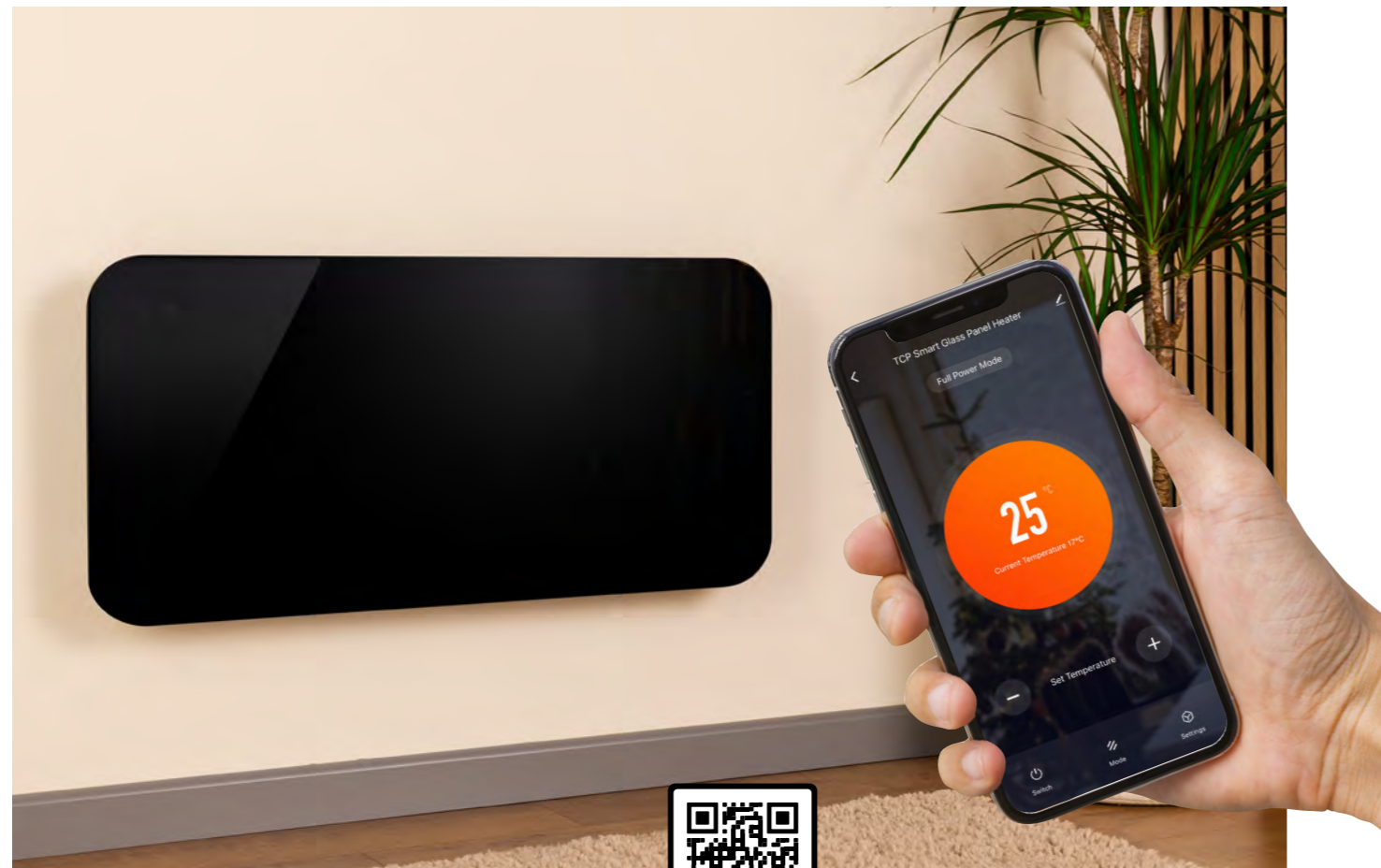

WATCH VIDEO

TCP SMART BLACK GLASS PANEL RADIATOR

TCP Smart Free-Standing Glass Panel Radiator 2000W radiator with electronic thermostat, voice activation, timer, schedules, and other smart controls via the TCP Smart App.

-  **App & Voice Control**
-  **2 Heat Settings**
-  **Glass Finish**
-  **Smart Timers & Schedules**
-  **Digital Screen**
-  **Anti Frost Mode**

Product Specifications

Instant heat	
Weekly programming	
Digital screen	LCD
Anti frost mode	
Over heat protection	
Wall mounted and free standing	
Dimensions	W 830 x D 72 x H 390 MM
Dimensions (with feet)	W 830 x D 240 x H 450 MM
Power	2000 W
Area coverage	20 M ²
Voltage / Frequency	220-240 V / 50/60Hz



Colour	Black
Material	Glass
Weight	6.8 KG
IP rating	IP24
Cable length	1.5 M
WiFi	2.4 GHz
Product Code	SMARADGBL2000UK
Barcode	8720039606319



WATCH VIDEO

TCP SMART WHITE GLASS PANEL RADIATOR

TCP Smart Free-Standing Glass Panel Radiator 2000W radiator with electronic thermostat, voice activation, timer, schedules, and other smart controls via the TCP Smart App.

-  **App & Voice Control**
-  **2 Heat Settings**
-  **Glass Finish**
-  **Smart Timers & Schedules**
-  **Digital Screen**
-  **Anti Frost Mode**

Product Specifications

Instant heat	
Weekly programming	
Digital screen	LCD
Anti frost mode	
Over heat protection	
Wall mounted and free standing	
Dimensions	W 830 x D 72 x H 390 MM
Dimensions (with feet)	W 830 x D 240 x H 450 MM
Power	2000 W
Area coverage	20 M ²
Voltage / Frequency	220-240 V / 50/60Hz

Colour	White
Material	Glass
Weight	6.8 KG
IP rating	IP24
Cable length	1.5 M
WiFi	2.4 GHz
Product Code	SMARADGWH2000UK
Barcode	8720039606333



WATCH VIDEO

TCP SMART BLADELESS FAN HEATER 1500W

TCP Smart Heating and Cooling Fan Portable 1500W ceramic heater with oscillation, electronic thermostat, and smart control.

- Instant Heat**
- Schedules & Timers**
- App & Voice Control**
- 2 Heating Modes**
- Digital Screen**
- Wide Angle Oscillation**

Product Specifications

TCP Smart voice control	Alexa, Google Home & Siri Shortcuts
TCP Smart app control	iOS & Android
Smart schedules & timers	
Instant heat	
Heat modes	2
Digital screen	LCD
Over heat protection	
Portable	
Dimensions	W 180 x D 180 x H 370 MM
Power	1500 W
Area coverage	8-12 M ²

Voltage / Frequency	220-240 V / 50Hz
Colour	Black / White
Weight	2.2 KG
IP rating	IPX0
Cable length	1.6 M
WiFi	2.4 GHz
Product code (Black)	SMABLFAN1500WBHN1903
Barcode (Black)	8720039608283
Product code (White)	SMAWHFAN1500WBHN1903
Barcode (White)	8720039608177



WATCH VIDEO

TCP SMART DOWNFLOW HORIZONTAL

TCP Smart Downflow Wall Heater 2000W - Compact ceramic heater with TCP Smart App, voice control, remote, and scheduling. Ideal for wall mounting in bathrooms and home offices.

- Instant Heat**
- Schedules & Timers**
- App & Voice Control**
- 2 Heating Modes**
- IP22**
- Remote**

Product Specifications

TCP Smart voice control	Alexa, Google Home & Siri Shortcuts
TCP Smart app control	iOS & Android
Smart schedules & timers	
Instant heat	
Heat modes	2
Digital screen	LCD
Remote control included	
Over heat protection	
Open window detection	
Dimensions	W 450 x D 100 x H 196 MM
Power	2000 W

Area coverage	15 M ²
Voltage / Frequency	230 V / 50-60Hz
Colour	White
Weight	2 KG
IP rating	IP22
Cable length	1.6 M
WiFi	2.4 GHz
Product code	SMAWHHEAT2000WHOR705
Barcode	8720039608160



TCP SMART TOWEL RADIATOR BLACK / WHITE 500W

TCP Smart Wi-Fi Electric Towel Radiator 500W radiator with 1700 BTU, Delta T 60°C, thermostatic control, voice activation, timer, schedules, and other smart controls via the TCP Smart App.

- App & Voice Control**
- Smart Timers & Schedules**
- 2 Heat Modes**
- IP24**
- Digital Screen (Twistable)**

Product Specifications

TCP Smart voice control	Alexa, Google Home & Siri Shortcuts	Voltage / Frequency	230 V / 50-60 Hz
TCP Smart app control	iOS & Android	Weight	9.8 KG
Smart schedules & timers		IP rating	IP24
Heat modes	2	Cable length	1.3 M (no plug)
Digital screen	Twistable LCD	WiFi	2.4 GHz
Dimensions	W 500 x D 75 x H 895 MM	BTU rating 1700 / Delta T 60°C	
Power	500 W		
Product code	SMAWHTOWRAIL500W05EW	SMABLTOWRAIL500W05EW	
Colour	Black	White	
Barcode	8720039609211	8720039608252	

TCP SMART TOWEL RADIATOR BLACK 1000W

TCP Smart Wi-Fi Electric Towel Radiator 1000W radiator with 3400 BTU, Delta T 60°C, thermostatic control, voice activation, timer, schedules, and other smart controls via the TCP Smart App.

- App & Voice Control**
- Smart Timers & Schedules**
- 2 Heat Modes**
- IP24**
- Digital Screen (Twistable)**





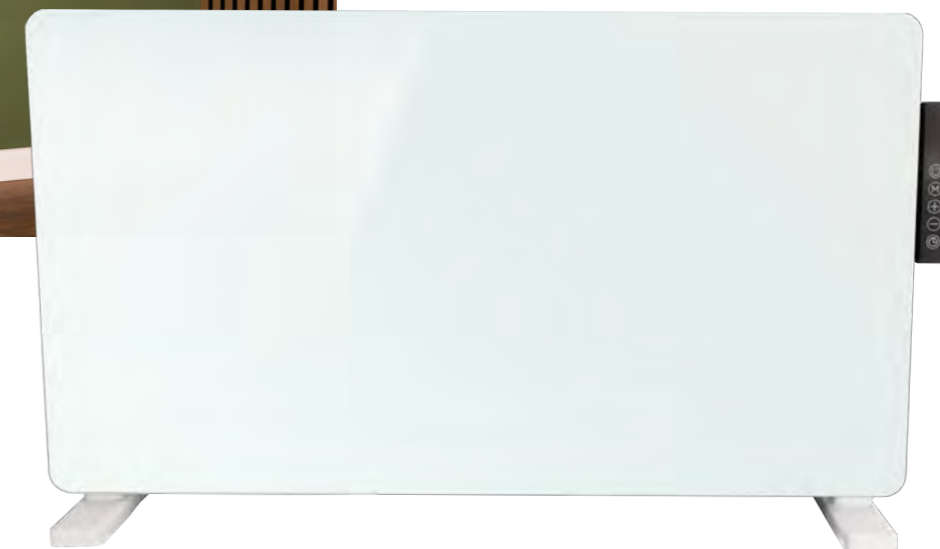
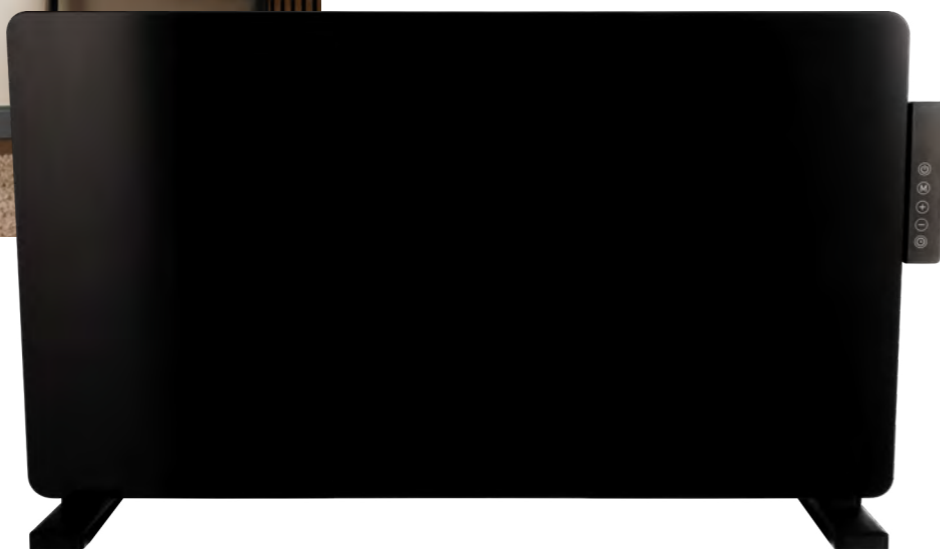

Product Specifications

TCP Smart voice control	Alexa, Google Home & Siri Shortcuts	Cable length	1.3 M (no plug)
TCP Smart app control	iOS & Android	WiFi	2.4 GHz
Smart schedules & timers		BTU rating 3400 / Delta T 60°C	
Heat modes	2	Product code	SMABLTOWRAIL1000W10E
Digital screen	Twistable LCD	Barcode	8720039609716
Dimensions	W 500 x D 75 x H 1340 MM		
Power	1000 W		
Voltage / Frequency	230 V / 50-60 Hz		
Colour	Black		
Weight	14.7 KG		
IP rating	IP24		



TCP BLACK GLASS PANEL HEATER 2000W

The TCP 2000W Glass Panel Heater combines sleek black-glass design with smart, efficient heating for rooms up to 20m². With weekly programming, a 9-hour timer, window detection, and anti-frost mode, it offers customizable comfort and energy-saving features. Quiet, stylish, and safe with overheat protection and IP24 splash resistance, it's ideal for living rooms, bedrooms, or offices—wall-mounted or freestanding.



-  **Glass Finish**
-  **Temp Settings 5° - 35°**
-  **Timer**
-  **Overheat protection**
-  **Window Detection**
-  **Digital Screen**

Product Specifications

Tempered Safety Glass with Safety Cover	Material	Glass
Overheat Protection	Weight	6.6 KG
Window Open Function	IP rating	IP24
9hr Timer	Cable length	1.5 M
Digital Screen	Product code	TCPRADGBL2000WSPG07
Dimensions	Barcode	8720039604766
Dimensions (with feet)		
Power		
Area coverage		
Voltage / Frequency		
Colour		

TCP WHITE GLASS PANEL HEATER 2000W

The TCP 2000W Glass Panel Heater combines sleek white-glass design with smart, efficient heating for rooms up to 20m². With weekly programming, a 9-hour timer, window detection, and anti-frost mode, it offers customizable comfort and energy-saving features. Quiet, stylish, and safe with overheat protection and IP24 splash resistance, it's ideal for living rooms, bedrooms, or offices—wall-mounted or freestanding.

-  **Glass Finish**
-  **Temp Settings 5° - 35°**
-  **Timer**
-  **Overheat protection**
-  **Window Detection**
-  **Digital Screen**







Product Specifications

Tempered Safety Glass with Safety Cover	Material	Glass
Overheat Protection	Weight	6.6 KG
Window Open Function	IP rating	IP24
9hr Timer	Cable length	1.5 M
Digital Screen	Product code	TCPRADGWH2000WSPG07
Dimensions	Barcode	8720039604759
Dimensions (with feet)		
Power		
Area coverage		
Voltage / Frequency		
Colour		



TCP BLACK INFRARED CONVECTION HEATER 2000W

TCP 2000W Panel Heater which uses both infrared and convection heating technology. Suitable for both wall mounting and free standing. With weekly programming, a LCD display, and manual controls for efficient heating and convenience.

-  **Instant Heat**
-  **Weekly Programming**
-  **Digital Screen**
-  **Temp Settings 5° - 35°**
-  **24 Hour Timer**
-  **Window Open Function**

Product Specifications







Instant heat	
Weekly programming	
Digital screen	LED
Temperature settings	5° - 35°
24 hour timer	
Window open function	
Over heat protection	
Thermal cut-out protection	
Wall mounted and free standing	
Dimensions	W 820 x D 90 x H 450 MM
Dimensions (with feet)	W 820 x D 220 x H 450 MM

Power	2000 W
Area coverage	15-20 M ²
Voltage / Frequency	220-240 V / 50/60Hz
Colour	Black
Material	Aluminium
Weight	7.2 KG
IP rating	IP24
Cable length	1.5 M
Product code	TCPCHHEAT2000WSPD06
Barcode	8720039604223



TCP BLACK PANEL HEATER 2000W

TCP 2000W Convection Panel Heater. Suitable for both wall mounting and free standing. With weekly programming, a LCD display, and manual controls for efficient heating and convenience.

-  **Instant Heat**
-  **Weekly Programming**
-  **Digital Screen**
-  **Temp Settings 5° - 35°**
-  **Window Open Function**
-  **Anti Frost Mode**

Product Specifications

Instant heat	
Weekly programming	
Digital screen	LED
Temperature settings	5° - 35°
Window open function	
Anti frost mode	
Over heat protection	
Thermal cut-out protection	
Wall mounted and free standing	
Dimensions	W 820 x D 90 x H 450 MM
Dimensions (with feet)	W 820 x D 220 x H 450 MM

Power	2000 W
Area coverage	15-20 M ²
Voltage / Frequency	220-240 V / 50/60Hz
Colour	Black
Material	Aluminium
Weight	7.2 KG
IP rating	IP24
Cable length	1.5 M
Product code	TCPCHHEAT2000WHPH08
Barcode	8720039604193



TCP WHITE INFRARED CONVECTION HEATER 2000W

TCP 2000W Panel Heater which uses both infrared and convection heating technology. Suitable for both wall mounting and free standing. With weekly programming, a LCD display, and manual controls for efficient heating and convenience.

- Instant Heat**
- Weekly Programming**
- Digital Screen**
- Temp Settings 5° - 35°**
- 24 Hour Timer**
- Window Open Function**

Product Specifications

Instant heat	
Weekly programming	
Digital screen	LED
Temperature settings	5° - 35°
24 hour timer	
Window open function	
Over heat protection	
Thermal cut-out protection	
Wall mounted and free standing	
Dimensions	W 820 x D 90 x H 450 MM
Dimensions (with feet)	W 820 x D 220 x H 450 MM

Power	2000 W
Area coverage	15-20 M ²
Voltage / Frequency	220-240 V / 50/60Hz
Colour	White
Material	Aluminium
Weight	7.2 KG
IP rating	IP24
Cable length	1.5 M
Product code	TCPWHHEAT2000WSPD06
Barcode	8720039604216



TCP WHITE PANEL HEATER 2000W

TCP 2000W Convection Panel Heater. Suitable for both wall mounting and free standing. With weekly programming, a LCD display, and manual controls for efficient heating and convenience.

- Instant Heat**
- Weekly Programming**
- Digital Screen**
- Temp Settings 5° - 35°**
- Window Open Function**
- Anti Frost Mode**

Product Specifications

Instant heat	
Weekly programming	
Digital screen	LED
Temperature settings	5° - 35°
Window open function	
Anti frost mode	
Over heat protection	
Thermal cut-out protection	
Wall mounted and free standing	
Dimensions	W 820 x D 90 x H 450 MM
Dimensions (with feet)	W 820 x D 220 x H 450 MM

Power	2000 W
Area coverage	15-20 M ²
Voltage / Frequency	220-240 V / 50/60Hz
Colour	White
Material	Aluminium
Weight	7.2 KG
IP rating	IP24
Cable length	1.5 M
Product code	TCPWHHEAT2000WHPH08
Barcode	8720039604209



TCP WHITE ALUMINIUM PANEL HEATER 2000W

TCP White Aluminium Panel Heater 2000W wall-mounted heater with weekly programming, LCD display, and manual controls for efficient heating and convenience.

- Instant Heat**
- Weekly Programming**
- Digital Screen**
- Thermostat**
- 24 Hour Timer**
- Manual Controls**

Product Specifications

Instant heat	
Weekly programming	
Digital screen	LCD
Temperature settings	5° - 35°
24 hour timer	
Thermal cut-out protection	
Wall mounted	
Dimensions	W 1040 x D 103 x H 450 MM
Power	2000 W
Voltage / Frequency	220-240 V / 50/60Hz
Colour	White

Material	Aluminium
Area coverage	15-20 M²
Weight	9.1 KG
IP rating	IP24
Cable length	1.5 M
Product code	TCPWHHEAT2000WNCQ20
Barcode	8720039604179



TCP DOWNFLOW VERTICAL

TCP Vertical Downflow Wall Heater - Compact ceramic heater with remote control. Ideal for wall mounting in bathrooms and home offices.

- Instant Heat**
- 2 Heating Modes**
- Timer**
- IP24**
- Digital Screen**
- Remote**

Product Specifications

Instant heat	
Timer	
Timer	
Heat modes	2
Digital screen	LCD
Remote control	
Over heat protection	
Open window detection	
Dimensions	W 250 x D 113 x H 325 MM
Power	2000 W
Area coverage	15 M²

Voltage / Frequency	230 V / 50-60Hz
Colour	White
Weight	1.9 KG
IP rating	IP24
Cable length	1.6 M
WiFi	2.4 GHz
Product code	TCPWHHEAT2000BH705E
Barcode	8720039603905

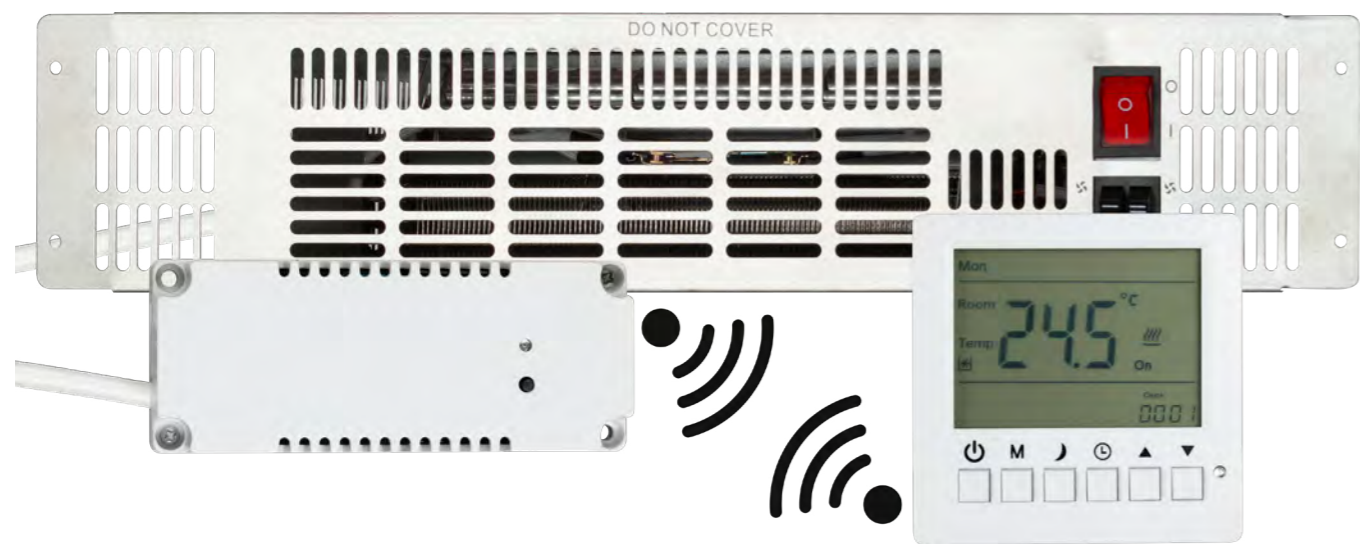

TCP PLINTH WITH REMOTE THERMOSTAT

The TCP 2000W Plinth Heater is a compact, energy-efficient unit designed to fit seamlessly into kitchen plinths or under cabinets. It features 2 heat settings plus a fan-only mode, a built-in thermostat, and overheat protection for safe, year-round comfort. Easy to install with a 1.7m pre-wired cable and rubber feet for quiet operation, it delivers powerful warmth without taking up floor space.

- Wireless RF Thermostat**
- Adjustable Thermostat**
- Digital Screen**
- 2 Heat Settings**
- Anti Frost Mode**
- Weekly Program**

Product Specifications	
Wireless Rf Thermostat	
2 Heat Settings	
Adjustable Thermostat	
Anti Frost Mode	
Digital Screen	LCD
Weekly Program	
Open Window Function	
Low Noise 58db(A)	
Dimensions	W 500 x D 225 x H 100 MM
Power	2000 W
Voltage / Frequency	220-240 V / 50/60Hz

Colour	Silver
Material	Stainless Steel
Weight	2.4 KG
IP rating	IPX0
Cable length	1.7 M (No Plug)
Product Code	TBYPLINHEATJKPH12NTL
Barcode	8720039602304

TCP AIR CURTAIN WITH REMOTE THERMOSTAT

The 3000W Air Curtain offers powerful, energy-efficient climate control for commercial spaces like shops, cafés, and gyms. With four operating modes, adjustable airflow direction, and a remote-controlled LED display, it's built for year-round comfort and convenience. Its rust-resistant body and easy-install bracket ensure long-lasting performance and simple setup above doorways.

- Wireless RF Thermostat**
- Adjustable Thermostat**
- Digital Screen**
- 2 Heat Settings**
- Anti Frost Mode**
- Weekly Program**

Product Specifications	
Wireless Rf Thermostat	
2 Heat Settings	
Adjustable Thermostat	
Anti Frost Mode	
Open Window Function	
Weekly Program	
Dimensions	W 580 x D 100 x H 180 MM
Power	3000 W
Voltage / Frequency	220-240 V / 50/60Hz
Colour	White
Material	Metal

Weight	4.6 KG
IP rating	IPX0
Cable length	1.5 M (No Plug)
Product Code	TCPWHAIRCURTJKTCP3KL
Barcode	8720039600188



TCP WHITE TUBULAR HEATER 1FT

The TCP 60W Tubular Heater is a compact, energy-efficient way to provide steady background heat in small or enclosed spaces. With a built-in thermostat and higher wattage than many similar models, it helps prevent damp and condensation in areas like sheds, greenhouses, and airing cupboards. Its plug-and-play design ensures easy installation and safe, quiet operation for continuous low-level warmth.

Product Specifications

Internal thermostat allowing for manual temperature control	
Temperature control range 0°C to 40°C	
Can withstand voltage of 2000V	
Vertically or horizontally mounted	
Dimensions	W 364 x D 55 x H 55 MM
Power	60 W
Voltage / Frequency	220-240 V / 50/60Hz
Colour	White
Area coverage	15-20 M²
Weight	0.68 KG
IP rating	IP44



Adjustable Thermostat



Temp Settings 0° - 40°



IP44



60W



Helps Reduce Damp & Condensation

Cable length	Wired product
Product code	TCPWHTUBULARHEAT60W
Barcode	8720039604728



TCP WHITE TUBULAR HEATER 2FT

The TCP 120W Tubular Heater provides efficient, low-level heat for medium-sized or enclosed spaces like sheds, garages, and greenhouses. With a built-in thermostat, higher wattage output, and plug-and-play design, it delivers reliable warmth while helping prevent damp and condensation. Safe, silent, and energy-efficient, it's an ideal year-round heating solution for outbuildings and utility areas.

Product Specifications

Internal thermostat allowing for manual temperature control	
Temperature control range 0°C to 40°C	
Can withstand voltage of 2000V	
Vertically or horizontally mounted	
Dimensions	W 667 x D 55 x H 55 MM
Power	120 W
Voltage / Frequency	220-240 V / 50/60Hz
Colour	White
Area coverage	15-20 M²
Weight	1.55 KG
IP rating	IP44



Adjustable Thermostat



Temp Settings 0° - 40°



IP44



120W



Helps Reduce Damp & Condensation

Cable length	Wired product
Product code	TCPWHTUBULARHEAT120W
Barcode	8720039604735



TCP TOWEL RADIATOR WITH INTEGRATED HEATER

The TCP 2-in-1 Tubular Towel Radiator and Downflow Heater combines a 300W oil-filled radiator with a 1kW turbo fan for both steady warmth and quick heat boosts. Its wall-mounted design saves space while drying towels and heating your bathroom efficiently. Featuring a sleek LED display with programmable settings, it's ideal for cold bathrooms, en-suites, and utility rooms.

Product Specifications

1000w Turbo Boost Fan	
Weekly Programming	
Overheat Protection	
Window Open Function	
Anti Frost Mode	
24hr Timer	
Digital Screen	LED
Dimensions	W 515 x D 107 x H 607 MM
Power	1300 W
Area coverage	8-12 M ²

- Weekly Program**
- Temp Settings 5° to 35° C**
- Timer**
- IP24**
- Digital Screen**
- Quiet**

Voltage / Frequency	230 V / 50Hz
Colour	Black
Material	Metal
Weight	8.4 KG
IP rating	IP24
Cable length	1.5 M
Product code	TCPBLTOWRAD1300ETC05
Barcode	8720039604742



TCP TOUGH FAN HEATER 2000W

The TCP 2kW Industrial Portable Heater delivers powerful, reliable heating in a compact, easy-to-move design. Built with a rugged industrial-grade casing, it's ideal for garages, workshops, warehouses, construction sites, and home extensions. Providing fast, efficient warmth, it transforms cold spaces into comfortable working areas in minutes. Durable, portable, and energy-efficient.

Product Specifications

Heat modes	2
PTC heating element	
Overheat protection	
Tip over safety switch	
Insulated plastic body	
Dimensions	W 210 x D 130 x H 260 MM
Power	1000 / 2000 W
Voltage / Frequency	220-240 V / 50/60Hz
Colour	Black & Yellow
Material	Plastic
Weight	1.4 KG

- 2 Heat Settings**
- Strong & Robust**
- Tip Over Safety Switch**
- PTC Heating Element**
- Overheat Protection**
- IP20**

IP rating	IP20
Cable length	1.5 M
Product code	TCPBLHEATBGP200120
Barcode	8720039604858



TCP SMART WHITE DEHUMIDIFIER 12L WITH HEPA FILTER

TCP White Smart Wi-Fi Dehumidifier 12L Powerful 185W compressor dehumidifier with HEPA filter, 12L daily removal, smart controls, 2L tank, and continuous drainage. Compact, quiet, and easy to maintain.

- App & Voice Control**
- Smart Timers & Schedules**
- Hepa Filter**
- 12L Extraction Per Day**
- Helps Reduce Moisture, Damp, Condensation & Mould**

Product Specifications

TCP Smart voice control	Alexa, Google Home & Siri Shortcuts
TCP Smart app control	iOS & Android
Smart schedules & timers	
Moisture extraction per day	12 L
Hepa filter - improves air quality removes air borne pollutants	
Low noise	36 dB(A)
Helps reduce moisture, damp, condensation & mould	
3 modes	Low, med & high 2 fan speeds
Tank capacity	2 L
Continuous extraction with hose	
Wheels for easy portability	

Dimensions	W 255 x D 220 x H 470 MM
Power	185 W
Area coverage	8-12 M²
Voltage / Frequency	220-240 V / 50/60Hz
Colour	White
Weight	11 KG
IP rating	IPX1
Cable length	1.5 M
WiFi	2.4 GHz
Product Code	SMAWDEHUM12LBD023AF
Barcode	8720039609686

TCP SMART WHITE DEHUMIDIFIER 20L

TCP White Smart Wi-Fi Dehumidifier 20L Powerful 314W compressor dehumidifier with 20L daily removal, smart controls, 4.3L tank, and continuous drainage. Compact, quiet, and user-friendly.

- App & Voice Control**
- Smart Timers & Schedules**
- 20L Extraction Per Day**
- Low Noise**
- Helps Reduce Moisture, Damp, Condensation & Mould**

Product Specifications

TCP Smart voice control	Alexa, Google Home & Siri Shortcuts
TCP Smart app control	iOS & Android
Smart schedules & timers	
Moisture extraction per day	20 L
Low noise	41 dB(A)
Helps reduce moisture, damp, condensation & mould	
3 modes	Low, med & high 2 fan speeds
Tank capacity	4.5 L
Continuous extraction with hose	
Wheels for easy portability	
Dimensions	W 305 x D 235 x H 495 MM

Power	314 W
Area coverage	15-25 M²
Voltage / Frequency	220-240 V / 50/60Hz
Colour	White
Weight	13.5 KG
IP rating	IPX1
Cable length	1.5 M
WiFi	2.4 GHz
Product Code	SMAWDEHUM20LBD068CF
Barcode	8720039609693



TCP WHITE 6L DEHUMIDIFIER

The TCP 6L Dehumidifier is a compact, quiet solution for reducing damp, condensation, and musty air in smaller spaces like bedrooms or offices. With a 6L daily capacity, auto shut-off, and an easy-carry handle, it offers safe, convenient moisture control wherever needed. Its modern, energy-efficient design fits seamlessly into any home.

Product Specifications

Continuous drainage with supplied hose	
Timer function	
Helps reduce moisture, damp, condensation & mould	
Moisture extraction per day	6 L
Low noise	
3 modes	Low, high & sleep
Tank capacity	2.1 L
Dimensions	W 270 x D 205 x H 406 MM
Power	180 W
Area coverage	10-15 M ²
Voltage / Frequency	220-240 V / 50/60Hz



6L Extraction Per Day



Tank / Continuous



Digital screen



Low Noise



Helps Reduce Moisture, Damp, Condensation & Mould

Colour	White
Weight	7 KG
IP rating	IPX0
Cable length	1.8 M
Product code	TCPWHDEHUM6FDD06
Barcode	8720039604919

TCP WHITE 30L DEHUMIDIFIER

The TCP 30L Dehumidifier efficiently removes excess moisture to help prevent damp, mould, and condensation in larger rooms and basements. With a 30L daily capacity, LED humidity indicators, a 24-hour timer, and a carbon filter, it offers clever, eco-friendly performance with air-purifying benefits. Its sleek design, wheels, and side handles make it easy to move and use throughout the home.

Product Specifications

Continuous drainage with supplied hose	
Timer function	
Helps reduce moisture, damp, condensation & mould	
Moisture extraction per day	30 L
Low noise	
3 modes	Low, high & sleep
Tank capacity	4.7 L
Dimensions	W 370 x D 270 x H 500 MM
Power	520 W
Area coverage	30-40 M ²
Voltage / Frequency	220-240 V / 50/60Hz



30L Extraction Per Day



Tank / Continuous



Digital screen



Low Noise



Helps Reduce Moisture, Damp, Condensation & Mould

Input	9V, 2.3A
Colour	White
Weight	14 KG
IP rating	IPX0
Cable length	1.8 M
Product code	TCPWHDEHUM30FDD30
Barcode	8720039603899



TCP WHITE 4 IN 1 AIR CARE

TCP White 4-in-1 Climate Control Versatile air circulator with HEPA air purifier, heating, cooling, humidifying functions, and remote control.

- Heater, Fan, Humidifier & Air Purifier with Mood Light**
- 2 Heat Settings**
- Hepa Filter**
- 8 Fan Speeds**
- Oscillation**

Product Specifications

Heater, fan, humidifier & air purifier	
Hepa filter - improves air quality removes air borne pollutants	
Anti tilt protection	
Over heat protection	
Oscillation	
Calming mood light	
LED display	
Remote control	
Low noise	56 dB(A)
2 modes	Low & high
Fan speeds	8 fan speeds

Dimensions	W 245 x D 213 x H 600 MM
Power	2000 W
Area coverage	25 M ²
Voltage / Frequency	220-240 V / 50/60Hz
Colour	White
Weight	3.4 KG
IP rating	IP20
Cable length	1.5 M
Product code	TCPWH4INIHYN2304RU
Barcode	8720039606555



TCP WHITE MINI DEHUMIDIFIER

TCP Mini Dehumidifier Compact 1L dehumidifier with semi-conductor cooling, ambient lighting (blue, green, orange, pink, purple, yellow & white), and 0.3ml daily moisture removal.

- 0.25L Extraction Per Day**
- 7 Ambient Lights**
- Digital screen**
- Low Noise**
- Helps Reduce Moisture, Damp, Condensation & Mould**

Product Specifications





Ambient light	7 static colours
Timer	6 / 12 / 24 Hours
Helps reduce moisture, damp, condensation & mould	
Moisture extraction per day	0.25 L
Low noise	36 dB(A)
3 modes	Low, high & sleep
Tank capacity	1 L
Dimensions	W 140 x D 113 x H 249 MM
Power	22.5 W
Area coverage	20 M ²
Voltage / Frequency	220-240 V / 50/60Hz

Input	9V, 2.5A
Colour	White
Weight	0.95 KG
IP rating	IPX0
Cable length	1.8 M
Product code	TCPWHDEHUM40001
Barcode	8720039602465



TCP STANDING COOLING FAN WITH 3D OSCILLATION

TCP Standing Cooling Fan. Stylish and quiet fan with adjustable height, 3D oscillation, and remote control.

-  **Multi Directional Air Flow & Oscillation**
-  **3 Fan Speeds**
-  **Remote Control**
-  **Whisper Quiet**
-  **Adjustable Height**

Product Specifications







Multi directional air flow & oscillation	Horizontal & Vertical
3 Fan Speeds	Low, medium & high
Whisper quiet	60 Db
Remote control	
Adjustable height	810 - 1050 MM
12 hour timer	
Digital display	LED
Manual controls	
Fragrance oil holder	
Dimensions	W 330 x D 330 H 810 - 1050 MM
Power	50 W

Area coverage	10-15 M²
Voltage / Frequency	220-240 V / 50/60Hz
Colour	Black Silver / White Silver
Weight	3.75 KG
IP rating	IPX0
Cable length	1.5 M
Product code	TCPFANBLSILFXL2316R
Barcode	8720039604650
Product code	TCPFANWHSILFXL2316R
Barcode	8720039604971



TCP 20" FLOOR FAN BLACK

TCP 20" Floor Fan with Remote Control delivers powerful, wide-reach airflow thanks to its large 20" blades, making it ideal for cooling larger rooms quickly and efficiently.

-  **Turbo Fan**
-  **3 Fan Speeds**
-  **Remote Control**
-  **20" Blades - wide air flow**
-  **Sleep Mode**
-  **Timer**

Product Specifications

Turbo fan	
20" Fan blades for wide air flow	
3 Fan speeds	Low, medium & high
Sleep mode	
Remote control	
Timer	0.5 - 4 Hours
Adjustable angle	160°
Stable floor standing design	
Light weight & easy to move	
Manual controls	
Dimensions	W 605 x D 250 H 600 MM

Power	50 W
Area coverage	230-346 M²
Voltage / Frequency	220-240 V / 50/60Hz
Colour	Black
Weight	4.1 KG
IP rating	IPX0
Cable length	1.8 M
Product code	TCPBLFLOORFANKYT50
Barcode	8720039604988



TCP BULKHEAD STANDARD

TCP IP65 Bulkhead Light - This eco-friendly, IP65 LED light offers switchable wattage and variable CCT. Suitable for indoor/outdoor use, wall/ceiling mounted. Made with recycled materials.



Quick Install



Multi Wattage



IP65



CCT - Warm to Cool

Product Specifications

Bulkhead	Standard	Working temperature	-10° to 40°C
Emergency	No	Mercury (Hg)	0 MG
Motion sensor	No	Start up time	0 Seconds
Colour temperature	3000K / 4000K / 6000K	Voltage / Frequency	220-240 V / 50/60Hz
Lumens	1100 - 1900 LM	Dimensions	W 300 x D 300 x H 75 MM
Power	11 W / 15 W / 19 W	Product Code	TCPWHBULKTPIP65BH300
IP rating	IP65 / IK10	Barcode	8720039606401
Lifetime	50,000 Hours		
Dimmable	Dimmable via step switch		
Beam angle	120°		
CRI	80		

TCP EMERGENCY BULKHEAD

TCP IP65 Bulkhead Light with Emergency - This eco-friendly, IP65 LED light offers emergency auto self test, switchable wattage and variable CCT. Suitable for indoor/outdoor use, wall/ceiling mounted. Made with recycled materials.



Quick Install



Emergency Battery (LIFEP04)



Multi Wattage



IP65



CCT - Warm to Cool

Product Specifications

Bulkhead	Emergency	Working temperature	-10° to 40°C
Emergency	Battery LIFEP04	Mercury (Hg)	0 MG
Motion sensor	No	Start up time	0 Seconds
Colour temperature	3000K / 4000K / 6000K	Voltage / Frequency	220-240 V / 50/60Hz
Lumens	1100 - 1900 LM	Dimensions	W 300 x D 300 x H 75 MM
Power	13.5 W / 17.5 W / 21.5 W	Product Code	TCPWHBULKTPBH300EM
IP rating	IP65 / IK10	Barcode	8720039609747
Lifetime	50,000 Hours		
Dimmable	Dimmable via step switch		
Beam angle	120°		
CRI	80		



TCP BULKHEAD WITH MOTION SENSOR

TCP IP65 Bulkhead Light with Microwave Sensor - This eco-friendly, IP65 LED light offers switchable wattage and variable CCT. Suitable for indoor/outdoor use, wall/ceiling mounted. Made with recycled materials.

- Quick Install**
- Multi Wattage**
- CCT - Warm to Cool**
- Microwave Motion Sensor**
- IP65**

Product Specifications

Bulkhead	Motion sensor	Working temperature	-10° to 40°C
Emergency	No	Mercury (Hg)	0 MG
Motion sensor	Microwave motion sensor	Start up time	0 Seconds
Colour temperature	3000K / 4000K / 6000K	Voltage / Frequency	220-240 V / 50/60Hz
Lumens	1100 - 1900 LM	Dimensions	W 300 x D 300 x H 75 MM
Power	11 W / 15 W / 19 W	Product Code	TCPWHBULKTPBH300MW
IP rating	IP65 / IK10	Barcode	8720039609471
Lifetime	50,000 Hours		
Dimmable	Dimmable via step switch		
Beam angle	120°		
CRI	80		

TCP EMERGENCY BULKHEAD WITH MOTION SENSOR

TCP IP65 Bulkhead Light with Emergency - This eco-friendly, IP65 LED light offers emergency auto self test, switchable wattage and variable CCT. Suitable for indoor/outdoor use, wall/ceiling mounted. Made with recycled materials.

- Quick Install**
- Multi Wattage**
- CCT - Warm to Cool**
- Emergency Battery (LIFEP04)**
- Microwave Motion Sensor**
- IP65**

Product Specifications

Bulkhead	Emergency motion sensor	Working temperature	-10° to 40°C
Emergency	Battery LIFEP04	Mercury (Hg)	0 MG
Motion sensor	Microwave motion sensor	Start up time	0 Seconds
Colour temperature	3000K / 4000K / 6000K	Voltage / Frequency	220-240 V / 50/60Hz
Lumens	1100 - 1900 LM	Dimensions	W 300 x D 300 x H 75 MM
Power	14 W / 18 W / 22 W	Product Code	TCPWHBULKTPBH300WEM
IP rating	IP65 / IK10	Barcode	8720039609877
Lifetime	50,000 Hours		
Dimmable	Dimmable via step switch		
Beam angle	120°		
CRI	80		



TCP OUTDOOR FLOODLIGHT

Easy installation with a screwless terminal connector, made from recycled materials. IP65 rated for indoor/outdoor use, and has a tempered glass diffuser for enhanced durability.



Quick Install



IP65



Screwless Terminal



Mixed Recycle Materials

Product Specifications	TCPLIGHT10W3434	TCPLIGHT20W3340	TCPLIGHT30W3443	TCPLIGHT50W3446
PIR motion sensor	No	No	No	No
Lumens	1600 LM	3200 LM	4800 LM	8000 LM
Colour temperature	4000K	4000K	4000K	4000K
Power	10w	20w	30w	50w
IP rating	IP65 / IK10	IP65 / IK10	IP65 / IK10	IP65 / IK10
Lifetime	30,000 Hours	30,000 Hours	30,000 Hours	30,000 Hours
Dimmable	Non dimmable	Non dimmable	Non dimmable	Non dimmable
Beam angle	120°	120°	120°	120°
CRI	70	70	70	70
Energy rating	C	C	C	C
Voltage / Frequency	220-240 V / 50/60Hz	220-240 V / 50/60Hz	220-240 V / 50/60Hz	220-240 V / 50/60Hz
Dimensions	W 130 x D 58 x H 108 MM	W 130 x D 89 x H 170 MM	W 185 x D 58 x H 130 MM	W 218 x D 58 x H 209 MM
Barcode	8720039606623	8720039606678	8720039607316	8720039607606



TCP FLOODLIGHT WITH PIR MOTION SENSOR

Easy installation with a screwless terminal connector, made from recycled materials. IP44 rated for indoor/outdoor use, and has a tempered glass diffuser for enhanced durability.



Quick Install



PIR Motion Sensor



IP44



Screwless Terminal



Mixed Recycle Materials





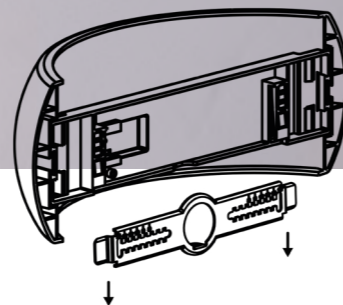

8m Sensor Range

Product Specifications	TCPLIGHT10WPIR8287	TCPLIGHT20WPIR8290	TCPLIGHT30WPIR8293	TCPLIGHT50WPIR8296
PIR motion sensor	Yes	Yes	Yes	Yes
Lumens	1600 LM	3200 LM	4800 LM	8000 LM
Colour temperature	4000K	4000K	4000K	4000K
Power	10w	20w	30w	50w
IP rating	IP44 / IK10	IP44 / IK10	IP44 / IK10	IP44 / IK10
Lifetime	30,000 Hours	30,000 Hours	30,000 Hours	30,000 Hours
Dimmable	Non dimmable	Non dimmable	Non dimmable	Non dimmable
Beam angle	120°	120°	120°	120°
CRI	70	70	70	70
Energy rating	C	C	C	C
Voltage / Frequency	220-240 V / 50/60Hz	220-240 V / 50/60Hz	220-240 V / 50/60Hz	220-240 V / 50/60Hz
Dimensions	W 130 x D 89 x H 170 MM	W 130 x D 89 x H 170 MM	W 185 x D 89 x H 192 MM	W 218 x D 89 x H 215 MM
Barcode	8720039606654	8720039606944	8720039607590	8720039607613



TCP WHITE UP DOWN WALL LIGHT

The TCP White Up and Down Wall Light - made from durable polycarbonate and 85% recycled materials. It features easy push-fit installation and requires an E14/SES bulb (max 18W).

-  **Quick Install**
-  **E14 / SES Cap Type**
-  **18w Max**
-  **1 Year Guarantee**
-  **Made with 85% Recycled Material**

Product Specifications



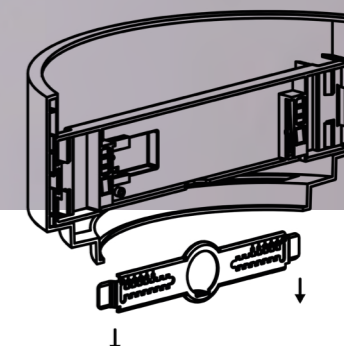

Quick install with wall bracket and push down light

Finish	White
Cap type	Small Screw E14 / SES
Power	Max 18 W
IP rating	IP20
Voltage / Frequency	220-240 V / 50/60Hz
Dimensions	W 268 x D 101 x H 90 MM
Product code	TCPWHUPDOWNW0002AM
Barcode	8720039606531
Bulb sold separately	



TCP WHITE 3 TIER WALL LIGHT

The TCP White 3-Tier Wall Light - made from durable polycarbonate and 85% recycled materials. It features easy push-fit installation and requires an E14/SES bulb (max 18W).

-  **Quick Install**
-  **E14 / SES Cap Type**
-  **18w Max**
-  **1 Year Guarantee**
-  **Made with 85% Recycled Material**

Product Specifications

Quick install with wall bracket and push down light

Finish	White
Cap type	Small Screw E14 / SES
Power	Max 18 W
IP rating	IP20
Voltage / Frequency	220-240 V / 50/60Hz
Dimensions	W 252 x D 106 x H 85 MM
Product code	TCPWHWALLLIGHTW0003AM
Barcode	8720039606593
Bulb sold separately	

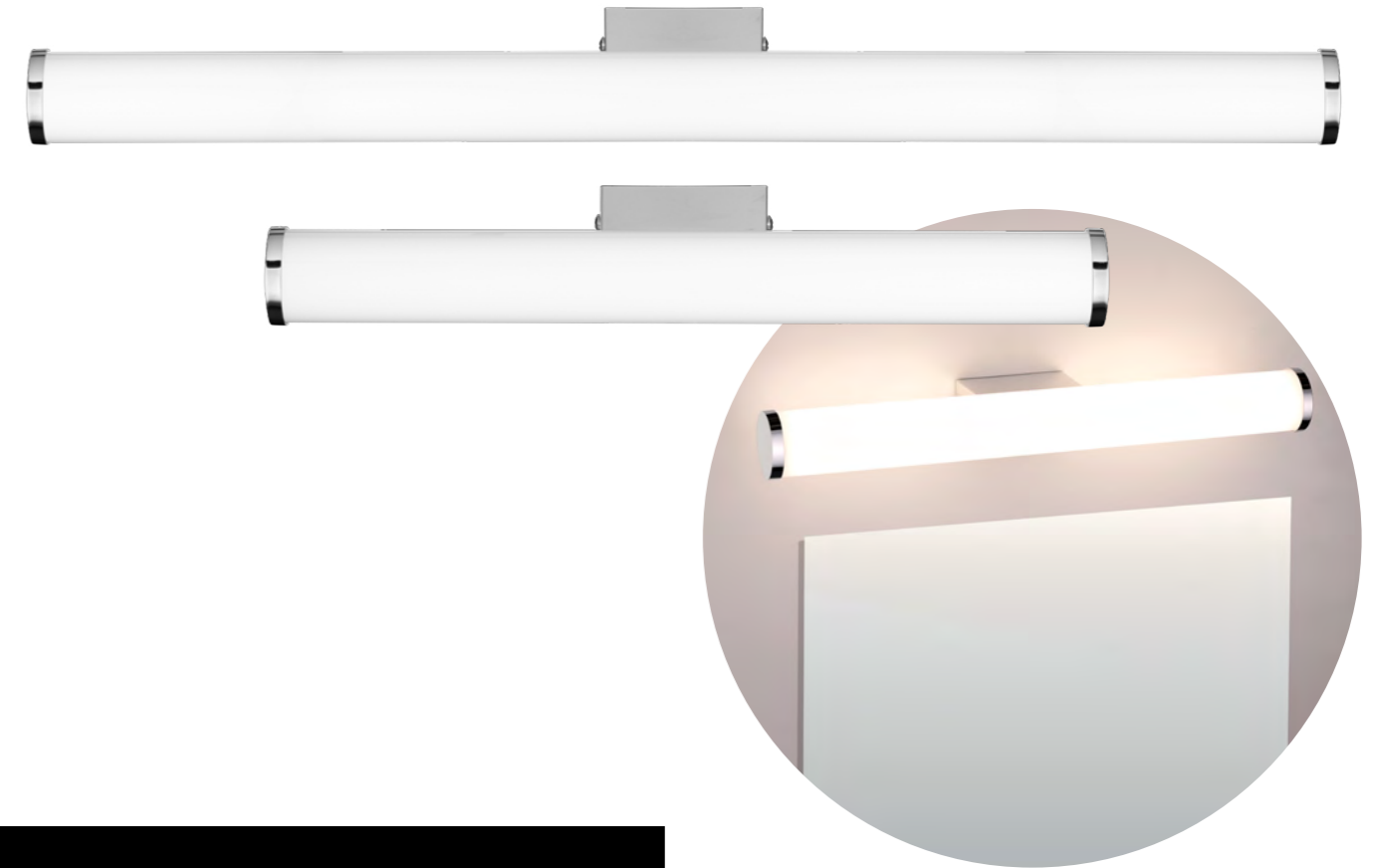

TCP INTEGRATED LED PENDANT LIGHT

The TCP Black Hanging Pendant 15W - Features an adjustable cable length (100-1500mm), is made from 90% recycled materials, and has an IP20 rating. It offers easy installation and a sleek matt black finish."

- Quick Install**
- Integrated LED Light**
- CCT - Warm to Cool**
- Adjustable Cable Length**
- Made with 90% Recycled Material**

Product Specifications	
Colour temperature	2700K / 3200K / 4000K
Technology	LED
Finish	Matt black
Lumens	3200 LM
Power	15 W
IP rating	IP20
Lifetime	30,000 Hours
Dimmable	Non dimmable
CRI	80
Start up time	0 Seconds
Voltage / Frequency	220-240 V / 50/60Hz

Dimensions (Min)	W 250 x D 250 x H 140 MM
Dimensions (Max)	W 250 x D 250 x H 1640 MM
Energy rating	E
Product code	TCPBLPEND15WPDR09250
Barcode	8720039606456

TCP MIRROR TUBE LIGHTS

Sleek design, cool 4000K light, and easy push-fit connection. Wall-mounted, IP44 rated.

- Quick Install**
- Soft Beauty Light**
- 8w / 12w**
- IP44**
- 1 Year Guarantee**
- Push Fit Terminal**

Product Specifications	
Colour temperature	4000K
IP rating	IP44
Lifetime	30,000 Hours
Dimmable	Non dimmable
CRI	80

Start up time	0 Seconds
Voltage / Frequency	220-240 V / 50/60Hz
Energy rating	D

Product code	TCPWHMIRRO8WML002AM	TCPWHMIRRO12WML002BM
Power	8 W	12 W
Lumens	800 LM	1200 LM
Dimensions	W 400 x D 100 x H 45 MM	W 600 x D 100 x H 45 MM
Barcode	8720039606425	8720039606432



WATCH VIDEO



WATCH VIDEO

TCP SMART BULB RGB COLOUR CHANGER & CCT SCREW

TCP Smart Colour Changing bulb with a choice of 16 million colours or warm to daylights. Can be controlled with your voice or the TCP Smart App.

- App & Voice Control**
- RGB Colour Changer**
- CCT Warm to Daylight**
- Music Sync**
- 806 Lumens**
- Smart Timers & Schedules**

Product Specifications

TCP Smart voice control	Alexa, Google Home & Siri Shortcuts
Real time energy and cost monitoring	
TCP Smart app control	iOS & Android
Smart schedules & timers	
Shape	Classic
Technology	LED / smart
Finish	Coated
Colour temperature	RGB / CCT warm to daylight
Cap	Screw E27 / ES
Lumens	806 LM
Actual wattage	9 W
EQ Wattage	60 W

Energy rating	F
Lifetime	15,000 Hours
Dimmable	Dimmable via TCP Smart app
Lumen cone	360°
CRI	80
Mercury (Hg)	0 MG
Start up time	0 Seconds
Voltage / Frequency	220-240 V / 50/60Hz
Dimensions	W 60 x H 112 MM
WiFi	2.4 GHz
Product code	SMBWLA806WOB215RCN1P
Barcode	8720039604063

TCP SMART BULB RGB COLOUR CHANGER & CCT SCREW

TCP Smart Colour Changing bulb with a choice of 16 million colours or warm to daylights. Can be controlled with your voice or the TCP Smart App.

- App & Voice Control**
- RGB Colour Changer**
- CCT Warm to Daylight**
- Music Sync**
- 806 Lumens**
- Smart Timers & Schedules**

Product Specifications

TCP Smart voice control	Alexa, Google Home & Siri Shortcuts
Real time energy and cost monitoring	
TCP Smart app control	iOS & Android
Smart schedules & timers	
Shape	Classic
Technology	LED / smart
Finish	Coated
Colour temperature	RGB / CCT warm to daylight
Cap	Bayonet B22 / BC
Lumens	806 LM
Actual wattage	9 W
EQ Wattage	60 W

Energy rating	F
Lifetime	15,000 Hours
Dimmable	Dimmable via TCP Smart app
Lumen cone	360°
CRI	80
Mercury (Hg)	0 MG
Start up time	0 Seconds
Voltage / Frequency	220-240 V / 50/60Hz
Dimensions	W 60 x H 112 MM
WiFi	2.4 GHz
Product code	SMBWLA806WOB215RCN1P
Barcode	8720039604056



TCP SMART STRIP LIGHT RGB COLOUR CHANGER & CCT

TCP Smart Colour Changing Strip Light with a choice of 16 million colours or warm to daylight. Can be controlled with your voice or the TCP Smart App.

- App & Voice Control**
- RGB Colour Changer**
- CCT Warm to Daylight**
- Music Sync**
- 1050 Lumens**
- Smart Timers & Schedules**

Product Specifications	
TCP Smart voice control	Alexa, Google Home & Siri Shortcuts
Real time energy and cost monitoring	
TCP Smart app control	iOS & Android
Smart schedules & timers	
Shape	Strip Light
Strip length	3 metres
Technology	LED / smart
Colour temperature	RGB / CCT warm to daylight
Lumens	1050 LM
Nominal wattage	13 W
IP rating	IP20
Energy rating	F

Lifetime	15,000 Hours
Dimmable	Dimmable via TCP Smart app
Lumen cone	360°
CRI	80
Mercury (Hg)	0 MG
Start up time	0 Seconds
Voltage / Frequency	12 V / 50/60Hz
Dimensions	W 10 x H 3000 MM
WiFi	2.4 GHz
Product code	SMAWTLRGBWIP203MUK
Barcode	8720039608023

TCP SMART OUTDOOR FLOOD LIGHT

This smart security light offers powerful 3000 lumen brightness with adjustable tilt, plus the choice of crisp white or 16 million colours. Control it easily via the TCP app or voice commands, with timers, schedules, and a 3-year guarantee included.

- App & Voice Control**
- RGB Colour Changer**
- CCT Warm to Daylight**
- Music Sync**
- 3000 Lumens**
- Smart Timers & Schedules**

Product Specifications	
TCP Smart voice control	Alexa, Google Home & Siri Shortcuts
Real time energy and cost monitoring	
TCP Smart app control	iOS & Android
Smart schedules & timers	
Shape	Flood Light
Remote control included	
Technology	LED / smart
Colour temperature	RGB / CCT warm to daylight
Lumens	3000 LM
Nominal wattage	30 W
IP rating	IP66
Energy rating	F

Lifetime	15,000 Hours
Dimmable	Dimmable via TCP Smart app
Lumen cone	360°
CRI	80
Mercury (Hg)	0 MG
Start up time	0 Seconds
Voltage / Frequency	100-240 V / 50/60Hz
Dimensions	W 146 x D 35 x H 170 MM
WiFi	2.4 GHz
Product code	SMAFLOODRGBCTIP66UK
Barcode	8720039607781



TCP DUSK TILL DAWN BULB

Automatically turns on at sunset and turns off at sunrise. Perfect for landings / hallways, porches, garden lamps and when homes are empty.



Dusk Till Dawn



Screw E27 / ES



Warm White



806 Lumens

Product Specifications

Shape	Classic
Technology	LED dusk till dawn
Finish	Coated
Colour temperature	Warm white 2700K
Cap	Screw E27 / ES
Lumens	806 LM
Nominal wattage	9 W
Actual wattage	9 W
EQ Wattage	60 W
Energy rating	E
Lifetime	15,000 Hours

Dimmable	Non dimmable
Lumen cone	360°
CRI	80
Mercury (Hg)	0 MG
Start up time	0 Seconds
Voltage / Frequency	220-240 V / 50/60Hz
Dimensions	W 60 x H 108 MM
Product code	TCPLA800DDE21527N1P
Barcode	8720039604162



TCP MOTION SENSOR BULB

Automatically turns on when motion is detected.

1. Motion detected
2. Light turns on for 30 seconds
3. Light turns off automatically after no motion detected



Motion Sensor



Screw E27 / ES



Warm White



806 Lumens

Product Specifications

Shape	Classic
Technology	LED motion sensor
Finish	Coated
Colour temperature	Warm white 2700K
Lumens	806 LM
Nominal wattage	9 W
Actual wattage	9 W
EQ Wattage	60 W
Energy rating	E

Lifetime	15,000 Hours
Dimmable	Non dimmable
Lumen cone	360°
CRI	80
Mercury (Hg)	0 MG
Start up time	0 Seconds
Voltage / Frequency	220-240 V / 50/60Hz
Dimensions	W 60 x H 112 MM

Product code	TCPLA806MSE21527N1P	TCPLA806MSB21527N1P
Cap	Screw E27 / ES	Bayonet B22 / BC
Barcode	8720039604155	8720039604148



TCP DECORATIVE LARGE GLOBE IRIDESCENT BULB

TCP Giant Iridescent Effect LED Bulb 4W - offers a warm 1800K glow, providing a vintage look. It is non-dimmable and energy-efficient, perfect for creating a cozy, ambient atmosphere.





-  **Decorative Large**
-  **Mirror Glass Finish**
-  **Warm White**
-  **Screw E27 / ES**
-  **50 Lumens**

Product Specifications	
Shape	Globe G200
Technology	LED Filament
Finish	Iridescent mirror glass
Colour temperature	Warm white 2700K
Cap	Screw E27 / ES
Lumens	50 LM
Nominal wattage	5 W
Actual wattage	4.6 W
Energy rating	G
Lifetime	15,000 Hours
Dimmable	Non dimmable

Lumen cone	360°
CRI	80
Mercury (Hg)	0 MG
Start up time	0 Seconds
Voltage / Frequency	220-240 V / 50/60Hz
Dimensions	W 200 x H 241 MM
Product code	DEBLG250IRIE21518N1P
Barcode	8720039604629
Not for general room illumination	
Decorative purposes only	

TCP DECORATIVE TEAR DROP AMBER BULB

TCP Giant Soft LED Filament 4W offers a warm 1800K amber glow, providing a vintage look. It is non-dimmable and energy-efficient, perfect for creating a cozy, ambient atmosphere.

-  **Decorative Large**
-  **Amber Glass Finish**
-  **Warm White**
-  **Screw E27 / ES**
-  **265 Lumens**

Product Specifications	
Shape	Tear drop S173
Technology	LED Filament
Finish	Amber glass
Colour temperature	Warm white 1800K
Cap	Screw E27 / ES
Lumens	265 LM
Nominal wattage	4 W
Actual wattage	4 W
Energy rating	G
Lifetime	15,000 Hours
Dimmable	Non dimmable

Lumen cone	360°
CRI	80
Mercury (Hg)	0 MG
Start up time	0 Seconds
Voltage / Frequency	220-240 V / 50/60Hz
Dimensions	W 173 x H 306 MM
Product code	DEBFS173265ATE21518
Barcode	8720039604513
Not for general room illumination	
Decorative purposes only	



TCP DECORATIVE SHORT HORN AMBER BULB

TCP Giant Short Horn LED Filament 4W offers a warm 1800K amber glow, providing a vintage look. It is non-dimmable and energy-efficient, perfect for creating a cozy, ambient atmosphere.

-  **Decorative Large**
-  **Amber Glass Finish**
-  **Warm White**
-  **Screw E27 / ES**
-  **250 Lumens**

Product Specifications

Shape	Short horn	Lumen cone	360°
Technology	LED Filament	CRI	80
Finish	Iridescent mirror glass	Mercury (Hg)	0 MG
Colour temperature	Warm white 1800K	Start up time	0 Seconds
Cap	Screw E27 / ES	Voltage / Frequency	220-240 V / 50/60Hz
Lumens	250 LM	Dimensions	W 180 x H 180 MM
Nominal wattage	4 W	Product code	DEBFSH250ATE21518N1P
Actual wattage	4 W	Barcode	8720039604537
Energy rating	G	Not for general room illumination	
Lifetime	15,000 Hours	Decorative purposes only	
Dimmable	Non dimmable		

TCP DECORATIVE T180 AMBER BULB

TCP "One" Series E27 T180 Amber 4W provides a warm 1800K amber glow, non-dimmable and energy-efficient, ideal for creating a cozy, vintage ambiance.

-  **Decorative Large**
-  **Amber Glass Finish**
-  **Warm White**
-  **Screw E27 / ES**
-  **200 Lumens**

Product Specifications

Shape	T180	Lumen cone	360°
Technology	LED Filament	CRI	80
Finish	Black glass	Mercury (Hg)	0 MG
Colour temperature	Warm white 1800K	Start up time	0 Seconds
Cap	Screw E27 / ES	Voltage / Frequency	220-240 V / 50/60Hz
Lumens	200 LM	Dimensions	W 180 x H 263 MM
Nominal wattage	4 W	Product code	DEBFT180200AVE21518
Actual wattage	4 W	Barcode	8720039604520
Energy rating	G	Not for general room illumination	
Lifetime	15,000 Hours	Decorative purposes only	
Dimmable	Non dimmable		



TCP DECORATIVE TEAR DROP BLACK BULB

TCP Giant Soft LED Filament 4W Black Glass offers a warm 1800K glow, providing a vintage look. It is non-dimmable and energy-efficient, perfect for creating a cozy, ambient atmosphere.

-  **Decorative Large**
-  **Warm White**
-  **50 Lumens**
-  **Black Glass Finish**
-  **Screw E27 / ES**

Product Specifications

Shape	Tear drop S173
Technology	LED Filament
Finish	Black glass
Colour temperature	Warm white 1800K
Cap	Screw E27 / ES
Lumens	50 LM
Nominal wattage	4 W
Actual wattage	4 W
Energy rating	G
Lifetime	15,000 Hours
Dimmable	Non dimmable

Lumen cone	360°
CRI	80
Mercury (Hg)	0 MG
Start up time	0 Seconds
Voltage / Frequency	220-240 V / 50/60Hz
Dimensions	W 173 x H 306 MM
Product code	DEBFS17350BTE21518
Barcode	8720039604568
Not for general room illumination	
Decorative purposes only	

TCP DECORATIVE SHORT HORN BLACK BULB

TCP Giant Short Horn LED Filament 4W Black Glass offers a warm 1800K glow, providing a vintage look. It is non-dimmable and energy-efficient, perfect for creating a cozy, ambient atmosphere.

-  **Decorative Large**
-  **Warm White**
-  **30 Lumens**
-  **Black Glass Finish**
-  **Screw E27 / ES**

Product Specifications

Shape	Short horn
Technology	LED filament
Finish	Iridescent mirror glass
Colour temperature	Warm white 1800K
Cap	Screw E27 / ES
Lumens	30 LM
Nominal wattage	4 W
Actual wattage	4 W
Energy rating	G
Lifetime	15,000 Hours
Dimmable	Non dimmable

Lumen cone	360°
CRI	80
Mercury (Hg)	0 MG
Start up time	0 Seconds
Voltage / Frequency	220-240 V / 50/60Hz
Dimensions	W 180 x H 180 MM
Product code	DEBFSH30BTE21518N1P
Barcode	8720039604599
Not for general room illumination	
Decorative purposes only	



TCP DECORATIVE T180 BLACK BULB

TCP "One" Series LED Filament 4W Black Glass offers a warm 1800K glow, providing a vintage look. It is non-dimmable and energy-efficient, perfect for creating a cozy, ambient atmosphere.

- Decorative Large**
- Black Glass Finish**
- Warm White**
- Screw E27 / ES**
- 20 Lumens**

Product Specifications

Shape	T180
Technology	LED Filament
Finish	Black glass
Colour temperature	Warm white 1800K
Cap	Screw E27 / ES
Lumens	20 LM
Nominal wattage	4 W
Actual wattage	4 W
Energy rating	G
Lifetime	15,000 Hours
Dimmable	Non dimmable

Lumen cone	360°
CRI	80
Mercury (Hg)	0 MG
Start up time	0 Seconds
Voltage / Frequency	220-240 V / 50/60Hz
Dimensions	W 180 x H 239 MM
Product code	DEBFT18020BVE21518
Barcode	8720039604575
Not for general room illumination	
Decorative purposes only	

TCP SMART FUSED SPUR WITH ENERGY MONITORING

This WiFi Fused Switch Spur is commonly used for fixed electrical appliances such as boilers, towel radiators, underfloor heating, or water heaters. It also monitors the electricity usage of the connected device, making power consumption management convenient and efficient.

Product Specifications

TCP Smart voice control	Alexa, Google Home & Siri Shortcuts
TCP Smart app control	iOS & Android
Smart schedules & timers	
Minimum depth wall box	25mm
Switch	1 gang
On / Off switch	Yes
Finish	White
Voltage / Frequency	220-240 V / 50/60Hz
Rated power	3000 W
Dimensions	W 85 x D 85 x H 47 MM
WiFi	2.4 GHz

- App & Voice Control**
- Smart Timers & Schedules**
- Rated Power 3000W**
- On / Off Switch**





BS 1363-3	
Product code	SMAFUSESPURWIFISFS
Barcode	8720039602373



WATCH VIDEO

TCP SMART PLUG WITH ENERGY MONITORING

TCP Smart Plug can add smart functionality to any electrical item with a plug, any energy used can be monitored in the app. Can be controlled with your voice or the TCP Smart App and add smart schedules and timers.





-  **App & Voice Control**
-  **Energy Monitoring**
-  **Smart Timers & Schedules**
-  **1 Gang**
-  **On / Off Switch**

Product Specifications	
TCP Smart voice control	Alexa, Google Home & Siri Shortcuts
Real time energy and cost monitoring	
TCP Smart app control	iOS & Android
Smart schedules & timers	
Swiath	1 gang
On / Off switch	Yes
Fuse	13 Amp
Voltage / Frequency	100-240 V / 50/60Hz
Rated power	3250 W
Dimensions	W 55 x D 55 x H 58 MM
WiFi	2.4 GHz

BS 1363-3	
Product code	SMAWISSINWMONITOR
Barcode	8720039609709

TCP SMART PLUG

TCP Smart Plug can add smart functionality to any electrical item with a plug. Can be controlled with your voice or the TCP Smart App and add smart schedules and timers.

-  **App & Voice Control**
-  **Smart Timers & Schedules**
-  **1 Gang**
-  **On / Off Switch**

Product Specifications	
TCP Smart voice control	Alexa, Google Home & Siri Shortcuts
TCP Smart app control	iOS & Android
Smart schedules & timers	
Swiath	1 gang
On / Off switch	Yes
Fuse	13 Amp
Voltage / Frequency	100-240 V / 50/60Hz
Rated power	3250 W
Dimensions	W 55 x D 55 x H 58 MM
WiFi	2.4 GHz
BS 1363-3	

Product code	TAYWISSINWUK
Barcode	8719638018821



TCP SMART 1-GANG 1-WAY SWITCH

Replace a standard switch with the TCP Smart Switch to add smart functionality. Can be controlled with your voice or the TCP Smart App and add smart schedules and timers.



App & Voice Control



Smart Timers & Schedules



1 Gang



On / Off Switch



Crystal Tempered Glass

Product Specifications

TCP Smart voice control	Alexa, Google Home & Siri Shortcuts
TCP Smart app control	iOS & Android
Smart schedules & timers	
Switch	1 gang
On / Off switch	Yes
Finish	Crystal tempered glass
Voltage / Frequency	220-240 V / 50/60Hz
Rated power	1000 W
Dimensions	W 86 x D 41 x H 86 MM
WiFi	2.4 GHz

BS 1363-3

Product code	SMAWWSSINWUK
Barcode	8719638018838

TCP SMART 2-GANG 1-WAY SWITCH

Replace a standard switch with the TCP Smart Switch to add smart functionality. Can be controlled with your voice or the TCP Smart App and add smart schedules and timers.



App & Voice Control



Smart Timers & Schedules



2 Gang



On / Off Switch



Crystal Tempered Glass

Product Specifications

TCP Smart voice control	Alexa, Google Home & Siri Shortcuts
TCP Smart app control	iOS & Android
Smart schedules & timers	
Switch	2 gang
On / Off switch	Yes
Finish	Crystal tempered glass
Voltage / Frequency	220-240 V / 50/60Hz
Rated power	1000 W
Dimensions	W 86 x D 41 x H 86 MM
WiFi	2.4 GHz

BS 1363-3

Product code	SMAWWSDOUWUK
Barcode	8719638018845



TCP 8-SOCKET EXTENSION LEAD WITH USB-C & USB-A

This UK 8-gang cube tower extension lead comes with a master power switch and 8 sockets for convenient use. It also includes 2 USB-C and 2 USB-A ports, allowing you to charge multiple devices simultaneously.

- 8** 8x Mains
- 2** 2x USB-A
- ⚡** 3250w Max
- 2** 2x USB-C
- 🔌** On / Off Switch
- 📏** 2M Cable Length

Product Specifications

Sockets	4x Main, 2x USB A & 2x USB C
5V 3.4A Max	
On / Off switch	Yes
Finish	White
Voltage / Frequency	220-250 V / 50/60Hz
Rated power	3250 W Max
Dimensions	W 85 x D 85 x H 113 MM
Cable length	2M
Product code	TCP8SOCKETCUBEUKT308
Barcode	8720039604995

TCP 4-SOCKET EXTENSION LEAD WITH USB-C & USB-A

This UK 4-gang cube tower extension lead comes with a master power switch and 8 sockets for convenient use. It also includes 2 USB-C and 2 USB-A ports, allowing you to charge multiple devices simultaneously.

- 4** 4x Mains
- 2** 2x USB-A
- ⚡** 3250w Max
- 2** 2x USB-C
- 🔌** On / Off Switch
- 📏** 2M Cable Length

Product Specifications

Sockets	4x Main, 2x USB A & 2x USB C
5V 3.4A Max	
On / Off switch	Yes
Finish	White
Voltage / Frequency	220-250 V / 50/60Hz
Rated power	3250 W Max
Dimensions	W 85 x D 85 x H 113 MM
Cable length	2M
Product code	TCP4SOCKETCUBEUKT304
Barcode	8720039605008



CONTACT US

Email: customerservice@tspi.eu
Phone: (01536) 201503
Website: www.tspi.eu